

## OpenVMS Technical Journal V8



### HP PERFDAT: A New Performance Solution for OpenVMS

Wolfgang Burger, Technical Consultant HP Service

Ewald Pieber, Solution Architect HP Service & OpenVMS Ambassador

Manfred Kaser, Technical Consultant HP Service & OpenVMS Ambassador

John Dite, Technical Consultant Compinia GmbH & Co. KG

#### **Overview**

This paper presents the OpenVMS performance and capacity planning solution called HP PERFDAT. HP PERFDAT performance solution for OpenVMS provides an unprecedented level of insight into multi-system performance. A complete suite of highly automated collection, filtering, charting and trend analysis capabilities provide the user with accurate and complete performance information for effective performance lifecycle management. The user interface was developed in close cooperation with customers in order to keep performance data analysis simple and intuitive and to enable the user to pinpoint performance problems and to identify their cause without OpenVMS internals knowledge. This article describes the basic concepts, main components and highlights the most important features of HP PERFDAT.

#### **The Performance Management Process**

*Long term measurement and observation of your system is the key to understanding how well the system performs and is invaluable in identifying potential performance problems before they become so serious that the system grinds to a halt so that it negatively affects your business. Thus, performance measurement should become a routine process of monitoring and measuring your systems to assure good performance through deliberate planning and resource management.*

*Performance management involves:*

- *Systematically collecting system data*
- *Gathering and analyzing the data*
- *Evaluating trends*

- *Archiving data to maintain a performance history*

*You will often observe trends and thus be able to address performance issues before they become serious and adversely affect your business operations. Should an unforeseen problem occur, your historical data will likely prove invaluable for pinpointing the cause and rapidly and effectively resolving the problem. Without past data from your formerly well-performing system, you may have no basis upon which to judge the value of the metrics you collect on your poorly performing system. Without historical data you are guessing; resolution will take much longer and cost far more.*

The preceding is the key initial statement in the *HP OpenVMS Performance Management* manual. Similar statements can be found in any document seriously dealing with performance and capacity management (e.g., ITIL process).

A prerequisite for effective OpenVMS performance management is to gather accurate and complete performance information of all OpenVMS subsystems. If performance measurements are inaccurate or incomplete, it is very likely that performance root-cause analysis will fail or lead to wrong conclusions.

Accurate and complete performance data is a prerequisite but it is not sufficient for effective performance management. Trend evaluation and data archiving to maintain a performance history have to be highly automated. Even if just one data file per day and system gets created by any OpenVMS performance data collector and your environment consists of only three nodes this will result in more than 1000 data files per year. If data management and trend evaluation is not highly automated, this has to be done manually, which may involve importing the performance data file to a utility such as Excel for charting. In case the amount of data in the performance data file exceeds the amount of data that can be processed by the target utility, which is very likely, the data file has to be pre-processed. You will probably have to copy data files from where the performance data is collected to the node where you analyze the data and to the node where you finally archive the data. Such manual tasks are time consuming and, consequently, costly activities. In addition, it may well happen that these manual trend and data management activities get postponed due to higher priority system management tasks. This can lead to situations where performance history is not immediately available when required, or huge amounts of data have to be processed manually in advance or, the worst case of all, historical data is lost.

### **The Birth of HP PERFDAT**

*“High available and high-performance IT services are critical to our business. Thus, we need a performance solution that supports the performance management process as well as the root-cause analysis of performance incidents without explicit expert knowledge time and be cost efficient . . . Such a performance solution has to be “plug and play” and should perform performance management tasks like trending highly automated, reliable and without any need of system management intervention . . . Performance data of our systems have to be available immediately when they are needed to be analyzed for any reason without any preceding data management or data pre-processing activities.”*

This was the key statement from the head of IT-operations of Austrian Lotteries – Thomas Müller-Guttenbrunn – when HP and Austrian Lotteries first discussed the key requirements that a performance solution for OpenVMS should fulfill in order to provide added value for their system management.

This discussion was triggered by Austrian Lotteries in 2003 when they started evaluating new performance solutions for OpenVMS since they found that their existing performance solution did not fulfill the basic prerequisite to collect accurate and complete performance information of all sub-systems of the most current OpenVMS version (OpenVMS V7.3-1 AXP) at that time. They complained especially about missing XFC statistics and that the performance data provided for the I/O sub-system were sometimes questionable which in turn made performance root-cause analysis difficult and sometimes impossible.

The result of that discussion was the requirements list shown below. After cross-checking the list with the ideas related to performance management of several other OpenVMS customers it was used to evaluate alternative performance solutions:

- High resolution performance data collection for easy root-cause analysis: Especially when analyzing performance issues of the I/O sub-system it is very often of special interest to know

which process causes heavy I/O load on a device or a specific file. None of the available performance data collectors available in 2003 provided this kind of information.

- Completeness of data: The data collector has to provide sufficient performance information about all sub-systems of OpenVMS including XFC and LAN and network protocol support.
- Plug and play: Once the performance solution is installed data has to be collected and all performance management related tasks like trending and data archiving have to be performed automatically to maintain a performance history based on predefined profiles, unattended, and without any need of additional customization work.
- Easy to manage and control.
- Online rule based performance alerting: Online performance alerting has to support system management to detect performance anomalies even though their impact does not slow down the overall system performance significantly so that this remains transparent to the end-user.
- Automated data management without any system management intervention.
- The ability to manage huge amounts of data (> 1 terabyte).
- Single point and transparent performance data access regardless of where the performance data is stored within the whole environment via a single common interface.
- Best practice workflow support based on a variety of statistical functions for any kind of performance analysis task in order to:
  - Reduce analysis time.
  - Receive feedback about what is going on without expert knowledge.
- Analysis tool that does not depend on the source data format – adhering to the principle of “Analyze what you get.”
- Data analysis without data pre-processing.
- Automatic trend and capacity reporting.
- Archive and housekeeping functionality.
- Open interface to map/import data from additional data sources (e.g., database, application, storage controllers and so forth) to guarantee collaboration with other performance data collection utilities.
- Performance data export capability to CSV files to guarantee collaboration with existing performance analysis utilities and charting tools. The format of a CSV export file (date/time format, list separator and decimal symbol) will be freely definable to avoid re-formatting the CSV export file before it can be used as input for a dedicated utility (e.g. Excel – CSV input format accepted depends on the regional settings).
- Data analysis will not depend explicitly or implicitly on the start time nor on the sample interval of any data collection.
- Easy data transfer of the performance database, or parts of it, for offline analysis.
- Up- and backward data compatibility.
- State of the art graphical GUI for data analysis:
  - Easy to handle.
  - Intuitive.
  - Easy data navigation.
  - Online descriptions for all statistics available.
  - State-of-the-art graphical features like:
    - Stack/unstack functionality.
    - Zoom in/out.
    - Shift left/right.
    - Data scanning.
    - Ability to scale graphs separately.
    - Auto, native, and manual scaling capability.
    - Data overlay capability (graphs of different time periods can be overlapped to allow visual comparison).
  - Correlation- and deviation analysis capability.
  - Multi window support for multi screen systems.
  - Export capability to Excel.
- Full cluster analysis capability.
- No dependency on any layered product except those available on the OpenVMS installation media.
- No dependency on any third-party product or any kind of shareware/freeware.

Austrian Lotteries tested T4 and ECP as alternatives to their current solution. None of these OpenVMS performance solutions fulfilled all the customer's requirements to the full extent. Thus, HP Austria decided to develop a new performance solution for OpenVMS in close cooperation with the customer.

This was the birth of HP PERFDAT performance solution for OpenVMS.

### **HP PERFDAT Design Considerations and Challenges**

When we look at the performance management process and at the requirements listed above, it is obvious that any performance solution consists of two major categories of components – those that collect performance data and those that process performance data (data trending, performance history maintenance, and so on) in a highly automated fashion. From the software design point of view, the key requirements are different for the data collecting and data processing components.

Performance data collectors have to provide complete and high-resolution performance data consuming as little system resources as possible. There is nothing worse in the context of performance data collection than that the data collecting process becomes the top consumer of system resources but does not provide the level of insight required.

When we designed HP PERFDAT, the top requirement for the data processing components was reusability. Reusability in this context means that a service provided by any of the data processing components can be applied to any data source. This can only be achieved if performance data is provided in a standardized format to the data processing service. Thus, data processing services have to be completely decoupled from the file and record structure of the data files provided by the performance data collectors. It was clear to us, that if we were able to decouple the data processing services from the source data format data access, problems related to version incompatibilities would never arise and the set of data processing components would be easily extendable.

Thus, during the initial design phase we were focussed on:

- Developing a high-resolution OpenVMS performance data collector
- Designing a generic data access model and, based on that, developing a common query interface

This section describes the major challenges we faced during the development of these two core components of HP PERFDAT and provides some insight into their design. Features have been added to both components over time but the base design remains unchanged.

#### HP PERFDAT OpenVMS Performance Data Collector

During the design phase we found that there were additional requirements to those already stated:

- High-resolution data collector that provides an unprecedented level of details.
- Completeness of data.
- Low system resource consumption.

These requirements are:

- The ability to handle several performance data collections in parallel:

This requirement derives from best practice considerations on how to use HP PERFDAT during the design phase. In most cases, a single performance data collection will be active on a system. Typically, this base collection will not be configured to collect all performance data that can be provided by the data collector but only a subset. Under normal condition this would be sufficient to perform all required performance management tasks and, in most cases, the performance data provided will also be sufficient for root-cause performance analysis as well. Sometimes, however, it may be the case that more detailed information has to be gathered for a defined period of time due to performance problems or due to just testing new application software. If the data collector were not able to handle several performance collections in parallel, the base collection would have to be stopped. As no other data collection is active during normal operations except the base collection, it will be

the source for all automated performance management related tasks. If the base collection has to be stopped, data will be missing in its data file exactly during a critical time period where performance problems were encountered or where software tests were performed. Thus, this missing data would have to be fetched from a different source for long-term analysis. This cannot be handled without manual intervention.

- No sample time drift when collecting performance data:

As long as you analyze performance data from a dedicated data collection for a short period of time it does not matter if the sample time drifts slowly over time. If you want to compare this data to performance data from another period of time or to data collected on other nodes with the same sample interval but a different time drift, you may get into trouble comparing them and as a result reach no, or wrong conclusions. Thus, archiving zero sample time drift was a prerequisite to us (if the selected sample interval is 60 seconds a performance data sample has to be taken exactly each 60 seconds and not 60.6 or 61.2 seconds).

- Performance data has to be collected simultaneously from all OpenVMS sub-systems:

If the time spent to gather all performance data from all OpenVMS subsystems is not negligible compared to the sample interval of the data collection (e.g., 0.5 seconds elapsed time to gather the performance data of a 2-second sample interval) you may get into trouble trying to analyze the data since the system state may have changed during the collection period.

- Files are referenced by their file ID and thus file IDs are available from OpenVMS data structures but no file names. To analyze I/O performance data of files one would rather request the file name than a file ID. To provide file name information the data collector has to maintain its own file name cache.
- Manageability.

Performance data can be collected by using the MONITOR utility or by the use of system services such as \$GETRMI, \$GETSYI, \$GETJPI, \$GETSPI (undocumented) and so on. The MONITOR utility as well as system services provide detailed performance information for particular subsystems. The problem is that this is not the case for all OpenVMS subsystems such as XFC, LAN, and network protocols and no interface exists that provides device I/O performance information on a per-file and/or per-process basis. One has the option to use the MONITOR utility and wrap some additional tools around it as T4 does, but in this case the requirements of:

- No sample time drift
- Simultaneous data collection
- Manageability
- Running several collections in parallel

can hardly be fulfilled. Thus, we decided to develop a single-process data collector and not a set of collector tools.

At first glance, extensive use of system services to collect performance data seems to be a good idea. System services are stable and are easy to use. On the other hand, the HP PERFDAT OpenVMS data collector has to provide highly detailed performance information but, at the same time, consume as few system resources as possible. Each system service call causes additional overhead compared to fetching the same information directly from OpenVMS data structures. Thousands of system service calls may be necessary whenever a performance data sample is taken. For example, if you want to collect process performance information for all processes active on a huge system with 4000 concurrent processes, 4000 \$GETJPI calls are required. This increases CPU load and the elapsed time to collect performance data. In this case, system services are used significantly compared to fetching the same performance data directly from the OpenVMS data structures.

This was the main reason we decided not to use system services but to fetch performance data directly from the data structures. In addition (almost) simultaneous data collection is more likely to occur compared to using system services since the run-time to collect data is much shorter. Most of the data fetches are performed at elevated IPL to prevent being re-scheduled during that period of time.

Not all performance data can be collected by actively gathering data from the data structures of OpenVMS. Device I/O performance data can be collected by using the call-back mechanism provided by the OpenVMS PMS subsystem. This feature tracks information about each I/O performed on the system. Special data structures and buffers have to be provided to OpenVMS to trigger the call-back mechanism. Once the call-back mechanism is enabled OpenVMS inserts information about each I/O performed on the system into these buffers. Up to 4 records are inserted per I/O, each at a different stage of the I/O flow. All information is provided to break down the I/O to devices, files, and process. Once a memory buffer is full, the collecting process is triggered to read and evaluate the entries in that buffer and OpenVMS switches to the next free buffer, if available, and proceeds to write I/O information. If OpenVMS finds no free buffer, the I/O information is dismissed. Thus, it is important that the calling process starts reading and evaluating the I/O information provided in the buffers immediately whenever it is triggered in order to guarantee that at least one free buffer is available to OpenVMS.

If the collecting process were single threaded, evaluating the I/O information buffers could be delayed due to other activities of the process, such as gathering other performance data or writing the data to the file.

The HP PERFDAT OpenVMS data collector was designed from the very beginning as a multi-threaded process. It consists of seven detached threads (see Figure 1):

- Active data sampling thread polling raw performance data but I/O information periodically.
- Reactive I/O sampling thread that exclusively evaluates the I/O information provided by the OpenVMS PMS sub-system.
- Three data collection worker threads processing the raw data provided by the active and reactive data sampling thread and writing this data to a file.
- Management thread that provides information to a management utility via mailboxes. It provides information about the actual status of all active collections, triggers collection startups, coordinates all other threads when a collection is requested to be stopped and is responsible for synchronized thread termination when shutting down the whole performance data collection process.
- File name resolving thread.

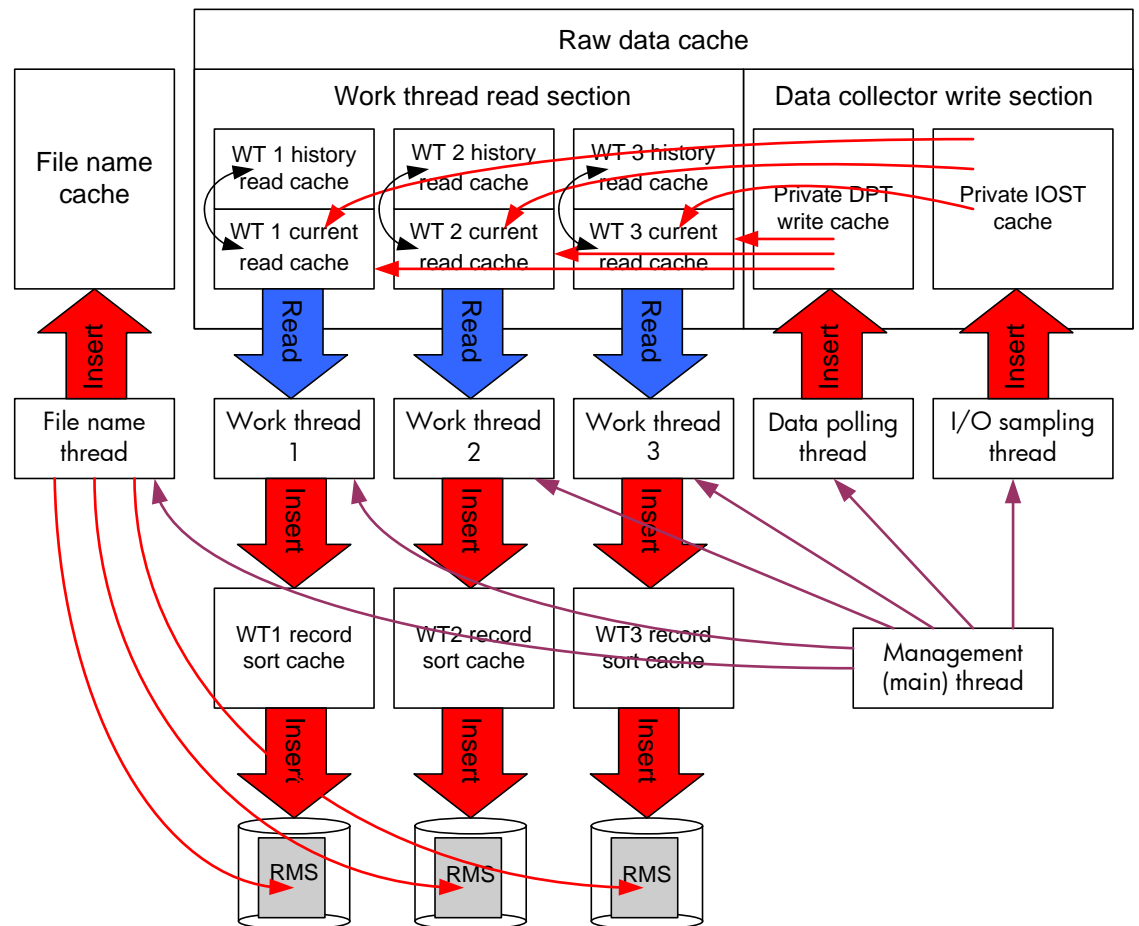

**Figure 1 - HP PERFDAT OpenVMS data collector thread and cache layout**

If a data collector process handles more than one data collection, you have the option to gather all required performance raw data separately for each collection. This is not efficient, however, since it is very likely that data sampling for all active performance data collections are periodically triggered at the same time. This means that the same kind of data is requested by each data collection and data is gathered unnecessarily. It is more efficient to have the raw data sampling threads separated from the “worker” threads as we call them. The sampling threads are triggered whenever the sample interval of an active data collection expires. If the sample interval of different collections expires at the same time, all performance raw data requested by each performance data collection is collected just once and inserted into the global raw data cache for post-processing.

With this design, the number of collections that can be active in parallel is just limited by the number of worker threads started. The current version of the performance data collector starts three worker threads. Thus, up to three data collections can be active in parallel.

The raw data cache is one of the most important components of the OpenVMS data collector and it is the key to the high efficiency of the collection process. To avoid synchronization delays when accessing data in the raw performance data cache, the cache is separated into a read and a write section. The read section consists of thread-specific regions each exclusively accessed by each of the worker threads. The write section consists of a region that is exclusively accessed by the active data sampling thread and one that is exclusively accessed by the reactive-I/O sampling thread. This means that thread run-time delays due to raw data cache synchronization can be avoided.

In most cases, data gathered from OpenVMS data structures are absolute counter values. When analyzing performance, one is interested in the change of these counters rather in their absolute values. Consequently, the raw data cache has to maintain not only raw data actually collected but also the raw performance data of the last sample interval for each data collection. Thus, each worker

thread region in the read section is divided into a current region containing the most recent data collected, and a historical region that contains performance raw data of the last sample interval collection.

Once data is requested from a worker thread due to sample interval expiration the active data sampling thread is triggered. It fetches data from the OpenVMS data structures and inserts it into its write-cache section region. In addition, it triggers the reactive-I/O sampling thread to dump the I/O data collected into its private region of the write-cache section. As both collection threads have signaled completion of their operation the content of both write regions is moved into the current regions of the read section of the calling threads, which are then triggered for post-processing. If the current region of a worker-thread read cache is not clear because the worker thread is still busy processing data of the last sample interval, then it is not replaced by the content of the write cache section and the worker thread is not triggered for post-processing. In this case, performance data will be lost for the actual sample interval in the data collection processed by that worker thread. All the signaling is done by event flags. Once a worker thread has completed all of its tasks, it clears the historical region and swaps its current and historical region.

It is obvious that the delay in addressing raw cache entries is critical to the overall performance of the OpenVMS data collector. A mixture of highly optimized hashing and block-cache algorithms is used to guarantee that all cache entries can be directly addressed or addressed via a minimum of hops. Optimizing all of the caching algorithms so that the data collector – even on huge, heavily loaded systems – provides in-depth, high-resolution performance information without harming system performance was the real challenge (For example, one of our customers uses PERFDAT on a CPU and I/O test system with approximately 3,000 concurrent processes. With 2 GB of performance data collected per day, the CPU load caused by the data collector is typically less than 6% of a single CPU.)

The worker threads are responsible for processing raw performance data and converting it into valuable data for performance analysis while making the data persistent by writing it to a dedicated file. Performance data files are stored in indexed sequential files. Each worker thread has to process and store all performance data within its sample time. Insert speed to the data files is also critical to the usability of the data collector. For this reason, performance data records are not written directly to RMS when they are created, but are cached in advance, ordered by their primary key. Only then are these records inserted in order to guarantee optimal RMS performance.

The file-name-resolving thread is responsible for file-ID-to-file-name resolution. As stated previously, OpenVMS provides file IDs when collecting file-related I/O performance counters. To resolve file IDs to file names synchronously is not an option since this would slow down the data insertion to such an extent that the whole data collector would become unusable. Thus, file-ID-to-file-name resolution is out-tasks to the file-name-resolving thread. Whenever a file-related data record is written to a file, the file ID is passed to the file-name-resolving thread. If the file name related to the ID received does not exist in the file name cache, it passes the file name asynchronously to all other threads using the LIB\$FID\_TO\_NAME run-time routine and adds it to its cache. Once the dedicated worker thread has inserted all its records to the data file, the file-name-resolving thread starts updating the file-name reference region in the appropriate data file of the worker thread. File names that refer file IDs that have been received from a worker thread and that are not marked as inserted into the worker thread's data file will be written. File IDs that have not been resolved up to that time will be inserted to the data file as soon they are available. It is guaranteed that the file-name-resolving thread blocks all data file inserts when the owner worker thread regains activity (the priority of performance-data inserts is higher than file-name inserts).

The higher the hit rate of the file-name cache when collecting file-related performance information, the less I/O load is caused by the data collector during the data collection phase. Thus, when the data collector is started all files currently known to OpenVMS are pre-cached before any performance data collection is triggered.

#### Generic Data Access Model and Common Query Interface.

The second core requirement of the HP PERFDAT solution for OpenVMS was the development of a generic data access model and a common query interface. This would guarantee that data from any



source is provided to any component in a standardized format. Thus, with this approach we would achieve a high level of reusability of all performance processing services. In addition, we would avoid any data access problems for all performance processing services caused by version incompatibilities. Under the envisioned design, any data can be accessed transparently regardless of which tool created the file or if, for example, the record format, size, or content changed from one HP PERFDAT release to the next. Data will stay accessible to any utility that accesses performance data via such an interface.

A common query interface that provides generic data access to any kind of data file has to contain a data abstraction layer that reads the records from the files in native format and converts them to a standardized format. This is obvious. The fundamental question, however, is which component of the overall HP PERFDAT environment should maintain the knowledge of the native record structure. Knowledge of the native record structure is the key for any data conversion.

One option is to bundle all required adapters, which, in fact, are software components, with the data abstraction layer. Typically, one would provide one adapter per data file type. The more data files of different types (different layout and record structures) that exist, the more adapters that have to be available. That is not the key point, however, and we were of the opinion that such an approach was not sufficient.

In principle, an approach such as this just displaces the version-dependency problems one would face if no data abstraction layer existed from the performance-processing services into the data abstraction layer. If the record format of a source data file changes, the appropriate adapter has to be changed too. In this case, data files containing the new data structure are accessible, but you will not be able to read data in a previous data format. In that case, the data abstraction layer has to provide both the old and the new adapter. Thus, for any change of data and/or file format new adapters have to be provided without removing the old ones. The number of adapter versions will continuously increase over time and we would end up with a hard-to-maintain data abstraction layer.

The other option is that the data abstraction layer of a common query interface does not have explicit knowledge of the record and file structure, but that the information is placed directly in the source file. In fact, nothing except the source that created the data files knows the data and record structure better. Thus, we adhere to the principle of letting the source tell all other components how to access the data.

All meta-data (field and record descriptors, data link descriptors, index reference table descriptors, and so on) required to access the data is stored in the header of each data file. The first record in the file is the link descriptor that points to where to find the descriptors in the file. Those are required for reading specific data from that file. This is the only structure that has to be common to the data abstraction layer and the sources of the data files. As long as the structure of the link descriptor does not change, the data abstraction layer can access data of any kind. Thus, record structures and data formats of the data file can be changed at any time without having any impact on the accessibility of data via the data abstraction layer.

Providing such a data abstraction layer fulfills all the requirements that are related to up- and backward data compatibility, but it does not fulfill all the requirements related to single-point access.

Data files are created periodically on each node within your environment running HP PERFDAT as shown in Figure 3. Transparent single-point data access has the following meaning to us. It is the ability to access all the data files from one single node regardless on which node the data files are located. This is exactly the challenge we faced when we talked about transparent single-point data access – where are the data files located?

Databases like Oracle Rdb maintain a root file that refers to the storage areas of the database. To create such a persistent root file for the sum of all data files (we call it the HP PERFDAT distributed performance database) within your environment is not possible since all nodes that run HP PERFDAT – even those that are not members of a cluster – would need access to a common disk. The only thing possible is to create and maintain a root file on each node that refers to the files stored locally. That root file contains references only to the data files that are locally accessible which is, in most cases, a small part of the whole HP PERFDAT distributed database.

## HP PERFDAT a new performance solution for OpenVMS – Wolfgang Burger

Our approach to that challenge was to design a network abstraction layer that services data queries similar to the way the data abstraction layer services data file content. The basic functionality of the network abstraction layer is comparable to routers.

When the networking abstraction layer starts up on a node (let's call this node the access server) it broadcasts a root file query to all nodes within the HP PERFDAT community. All remote nodes that have data files stored locally return their local root file information. The access server caches the data file information received and creates a virtual root file (non persistent – memory resident) of the whole HP PERFDAT distributed performance database (you can also call this a routing table).

Both the data and the network abstraction layer were the keys to fulfilling all the requirements related to data access as described in the previous section. These two layers represent the kernel of the common query interface that is used by all HP PERFDAT data processing services. Thus, all HP PERFDAT data processing services can transparently access any data independent of the source data format. The data file may be stored locally or on a server located hundreds of miles away – it makes no difference to the HP PERFDAT data processing services.

The common query interface has been extended over time, but the design of these two layers is still valid and unchanged. A brief description of all components that comprise the common query interface of the current HP PERFDAT version is provided in the next section.

### HP PERFDAT Architecture

This section provides an overview of the architecture, the components, and features available of the current HP PERFDAT version V3.2. HP PERFDAT V3.2 is supported on:

- OpenVMS V7.2-2 Alpha.
- OpenVMS V7.3 Alpha.
- OpenVMS V7.3-1 Alpha.
- OpenVMS V7.3-2 Alpha.
- OpenVMS V8.2 Alpha.
- OpenVMS V8.2 for Integrity servers.
- OpenVMS V8.2-1 for Integrity servers.

It consists of the following software components:

- HP PERFDAT OpenVMS Data Collector (up to 3 collections can be run simultaneously).
- HP PERFDAT SNMP extension – with the SNMP extension, any single OpenVMS node can collect performance data from up to 64 non-OpenVMS systems providing performance data via SNMP.
- Distributed performance database.
- PERFDAT configuration database.
- PERFDAT cluster view database.
- Data Query Interface/Data Query Language (DQL).
- Performance database file name cache service.
- Online performance alerting.
- Statistics package.
- HP PERFDAT Auto-archiving service and housekeeping.
- HP PERFDAT Auto-trend engine.
- Graphical User Interface.
- Management Interface (PERFDAT\_MGR).
- Tools and utilities.

Figure 2 shows the overall software architecture of the HP PERFDAT performance solution for OpenVMS.

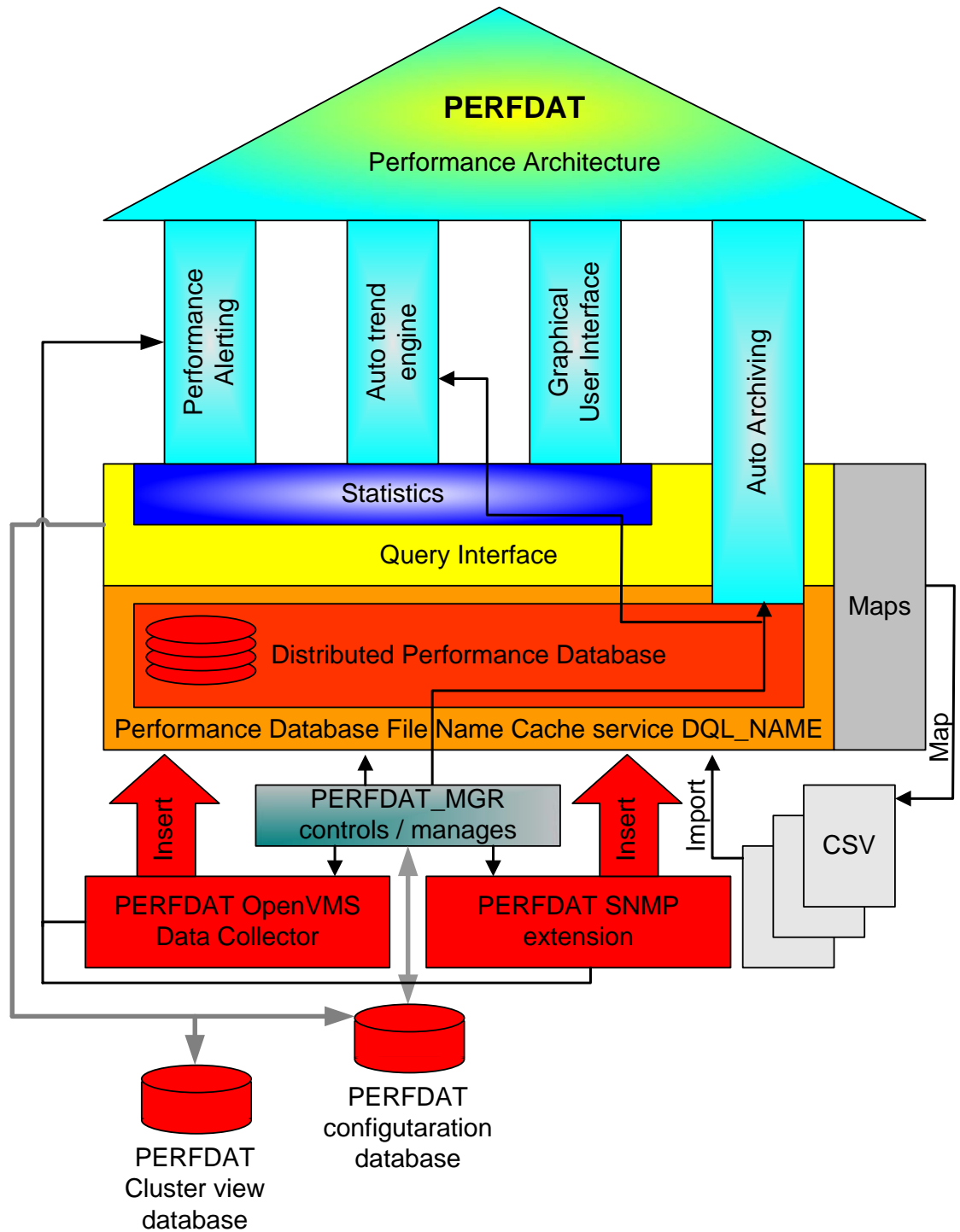

**Figure 2 - HP PERFDAT software architecture**

Although HP PERFDAT consists of several components it is truly plug and play. It is automatically configured during the installation process. The default configurations have been developed with OpenVMS customers and will fulfill customer needs in most cases. Once HP PERFDAT is installed, it is automatically started. All the important performance management activities such as creating trend reports and data archiving to maintain a performance history of your system are performed automatically and without any need for system management intervention. The only important post-installation activity is to add the HP PERFDAT startup and shutdown procedures to the site-specific OpenVMS startup and shutdown routine to guarantee that HP PERFDAT is automatically started when the system is (re)booted.

### HP PERFDAT OpenVMS Data Collector

The prerequisite for effective performance management is to gather accurate and complete performance information of any OpenVMS subsystem. If performance measurements are inaccurate or incomplete, it is very likely that the root-cause cannot be evaluated when analyzing a performance incidence.

HP PERFDAT provides today's most comprehensive OpenVMS data collector on the market. It gathers performance information of any OpenVMS subsystem with an unprecedented level of detail. It provides, for instance, full XFC support down to I/O-size statistics per file and LAN and network protocol statistics. It also gives you the ability to breakdown device I/Os to process and file level.

The main features of the HP PERFDAT OpenVMS data collector include:

- With the multi-threaded HP PERFDAT OpenVMS data collector up to 3 performance data collections can be performed in parallel – each with a different level of detail and metrics enabled.
- Performance data collections are profile controlled.
- These profiles can be defined offline before starting a collection.
- An auto-start collection profile can be defined to auto-start a performance collection whenever the HP PERFDAT OpenVMS data collector is (re)started.
- Performance data collections can be started and stopped automatically, manually, or scheduled to run for a predefined period of time.
- Performance data collections and their profiles are managed and controlled by the common management utility PERFDAT\_MGR.
- It collects more than 660 statistics organized in 23 metrics.
- The sample interval for gathering performance information of the OpenVMS sub-systems is freely definable (minimum = 1 sec)
- Each of the metrics can be enabled/disabled independently.
- Performance data collected can be restricted to single/multiple devices, processes, users, images, and volumes.
- I/O performance data (device metric) can be collected with unprecedented resolution. I/O performance data is not only collected per device, but also, for easy root-cause analysis, it can be collected per process and device; per file and device; and per process, file, and device on demand. Thus, hot file statistics as well as the perpetrator of hot files can be identified.
- I/O performance data can be collected for any type of class device (the device metric is not restricted to disk, tape, or mailbox devices).
- Files in the device and XFC metric are not only resolved to file IDs but also to their actual file names.
- Complete XFC integration.
- Full LAN and network protocol support.
- Dynamic resource trimming:

The HP PERFDAT OpenVMS data collector was designed to use the least amount of system resources as possible since the task of a performance data collector is to provide all the data required to analyze and resolve performance problems – not to cause them. Nevertheless, if data collections are started with the lowest sample interval possible without any device filters and all device and XFC options enabled, the OpenVMS data collector may become one of the top resource-consuming processes on the system. In order to avoid performance problems due to running HP PERFDAT, the OpenVMS data collector watches its own resource consumption, and if CPU load and/or I/O load exceeds definable thresholds, HP PERFDAT automatically increases the collection sample intervals and/or dismisses metrics according to internal rules.

- New performance data files are created daily for each active collection or whenever a performance data collection is (re)started. The daily data flush time can be freely defined.
- Permits online monitoring.

### **HP PERFDAT SNMP Extension**

The data from the HP PERFDAT OpenVMS data collector provides an unprecedented level of insight into system performance. However, this sometimes may not be sufficient for root-cause analysis, especially if your OpenVMS systems are attached to components that are not exclusively accessed by the OpenVMS systems like a SAN. In this case, the activity of other non-OpenVMS system may have a direct impact on the performance (especially I/O performance) of your OpenVMS systems. Thus, HP PERFDAT provides a SNMP extension to monitor any non-OpenVMS system that provides performance data via SNMP. Up to 64 remote systems can be monitored per OpenVMS node.

The HP PERFDAT SNMP extension support Brocade switches and Tru64 UNIX systems out of the box. If you want to monitor any other system that provides performance information via SNMP, you can customize the appropriate configuration tables.

The main features of the HP PERFDAT SNMP extension at a glance:

- Up to 64 remote nodes can be monitored in parallel.
- Performance data collections are profile controlled and these profiles can be defined offline before starting a collection.
- An auto-start collection profile can be defined to auto-start a performance collection for each remote system that shall be monitored whenever the HP PERFDAT SNMP extension is (re)started.
- Performance data collections can be started and stopped automatically, manually, or scheduled to run for a predefined period of time.
- Performance data collections of the HP PERFDAT SNMP extension and their profiles are managed and controlled by the common management utility PERFDAT\_MGR.
- Metrics and statistics are predefined for Tru64 UNIX systems and Brocade switches.
- Sample interval is freely definable (minimum = 1 minute).
- Each metric can be enabled/disabled independently.
- Permits online monitoring.
- Online performance alerting can be enabled dynamically.
- New performance data files are created daily for each active SNMP collection or whenever a performance data collection is (re)started. The daily data flush time can be freely defined.

### **Distributed Performance Database**

All data collected by the HP PERFDAT OpenVMS data collector and the HP PERFDAT SNMP extension is stored in index-sequential RMS files. As described in the previous sections, each data collector creates a new file daily or whenever a collection is started (or restarted). Thus, 1 to n data files can exist per day and collection. A single data file is called a physical storage area. All physical storage areas that are created on the same day and that belong to the same collection (collection profile and node) are called a logical storage area. Figure 3 presents a graphical overview of the database organization of the HP PERFDAT distributed database.

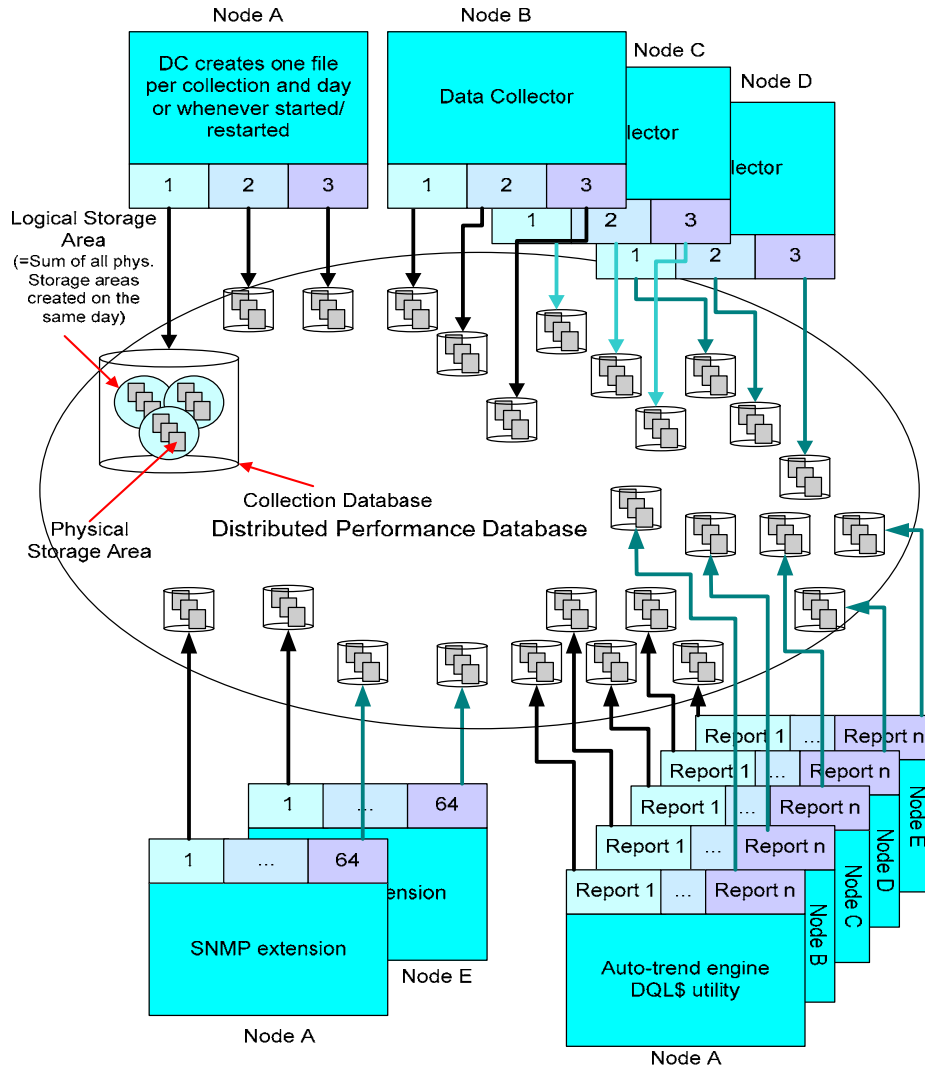

**Figure 3 - Database organization of the HP PERFDAT distributed database**

In addition to the HP PERFDAT OpenVMS data collector and the HP PERFDAT SNMP extension, performance data files are created by the auto-trend engine responsible for providing automated trend and capacity reports. Trend and capacity report data files contain data of a particular time period – called a report period (day, week, month, quarter, year) – defined by the report profile used to create these reports. At the end of such a predefined time period – or whenever the definitions of the report profile change – a new report data file is created. As with the data collector, a single report data file is also called a physical storage area. The sum of all physical storage areas that are created during a report period is called a logical storage. If the report period is WEEK, for example, all report data files created during a week make up the logical storage area for this report.

All logical storage areas created by the same data collection or the auto-trend engine using the same report profile make up a collection database. The sum of all collection databases available within your environment is called the HP PERFDAT distributed performance database (Fig. 3).

The data files of the distributed performance database can be stored on any node within your environment. HP PERFDAT distributed database data is accessed via the common DQL interface.

**HP PERFDAT DQL Interface**

HP PERFDAT DQL (Data Query Language) interface provides a common interface for transparent access to the distributed performance database. DQL is similar to SQL. All basic query statements such as SELECT, INSERT, CREATE, and DROP are supported except UPDATE and DELETE to prevent after-image data manipulation.

DQL provides single-point access to all HP PERFDAT performance data files regardless of where the data files are stored within your environment. Even if data files are literally spread all over the world there is no need for any manual data transfer or preprocessing to access and analyze performance data. The relocation or renaming of performance data files has no effect on the accessibility of the data.

All meta-data (field and record descriptors, data link descriptors, index reference table descriptor, and so on) necessary to access performance data in a data file is stored in the header of each physical storage area. Due to the fact that the DQL interface needs no implicit knowledge about the internal structure of the data files, there exists no version dependency when accessing performance data. Performance data accessed via the DQL interface is always readable independent of the OpenVMS and/or HP PERFDAT version with which the performance data was collected; the OpenVMS and/or HP PERFDAT version of the system where the performance data resides; or the version of the HP PERFDAT GUI used for data analysis.

Additional features of the DQL interface are as listed below:

- Ability to map/import CSV formatted performance data from additional data sources (for example, databases like Oracle Rdb, applications, and storage controllers) to guarantee collaboration with other performance data collection utilities. If a CSV file is mapped, the content of the CSV file can be accessed via the DQL interface as if it were part of the distributed performance database. In contrast to mapping a CSV data file, if you import the content of a CSV file to the distributed performance database it becomes part of the distributed performance data and is automatically handled by the HP PERFDAT data archiving service. Mapped CSV files are not handled by the HP PERFDAT archiving service. In addition, only a limited number of statistical methods and features to analyze performance data can be applied to mapped CSV content.
- Advanced performance data export capability to CSV files to guarantee collaboration with existing performance analysis utilities (e.g., TLViz) and charting tools (e.g., Excel). The format of a CSV export file (date/time format, list separator, and decimal symbol) is freely definable to avoid re-formatting the CSV export file before it can be used as input for a dedicated utility (e.g., Excel – CSV input format accepted depends on the regional settings).
- Multi file version support.
- Ability to define cluster views.
- User defined statistics:

User defined statistics are calculated values that can, once defined, be accessed as if they are part of the collection databases. There are several reasons for defining stored procedures. The most common are:

- You want to normalize data.
- You are interested in special statistics that are not directly collected by the HP PERFDAT OpenVMS data collector or the HP PERFDAT SNMP extension but all input parameters to compute these are available. For example, the average I/O size of disk devices is not directly collected by the OpenVMS data collector but throughput and I/O requests are. Thus, the average I/O size can be defined as a user-defined statistic:

Avg. I/O size = Throughput/I/O requests

- Statistics package fully integrated in data query interface. The query interface is not a monolithic layer but consists of six components as shown in Figure 4.
- DQL\$SRV (DQL server).
- Cluster view engine.
- Stored procedure engine.
- Statistics Package.
- DQL\$ command line utility.
- PDBC\$SRV (Performance database connectivity server).

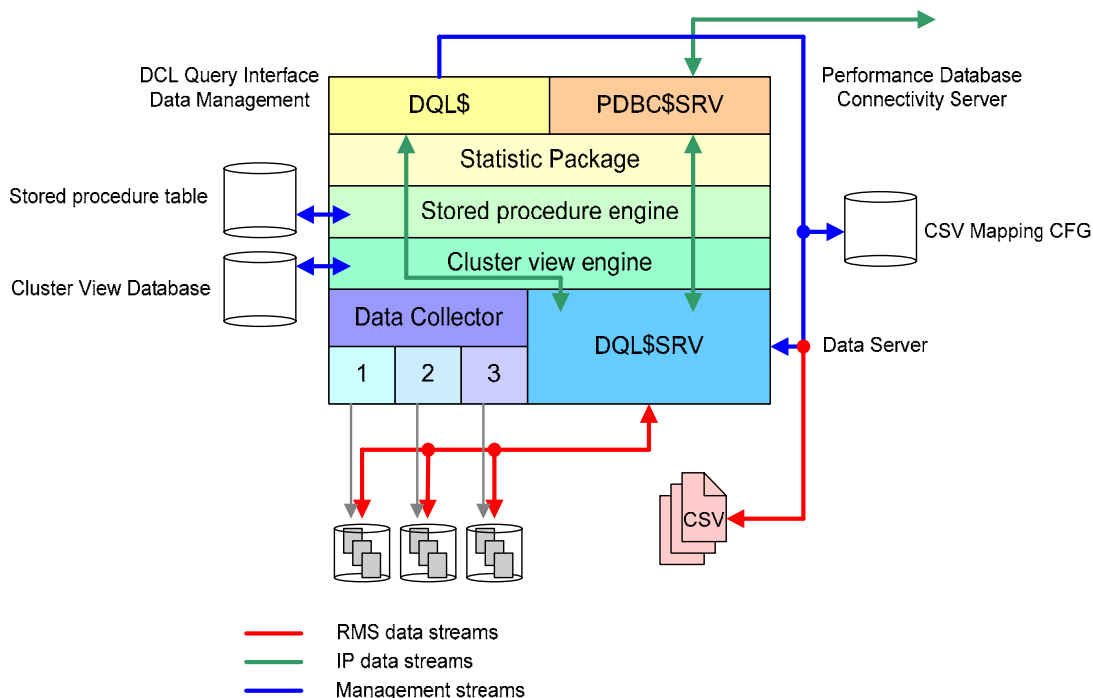

**Figure 4 - Components of the DQL interface**

#### DQL\$SRV (DQL Server)

The DQL\$SRV (DQL server) represents the data abstraction layer of the DQL interface. This component directly accesses the data of the performance data stored locally according to the definitions in the header of the data files. Its main task is to map the data query command received from the cluster view engine to RMS calls. Data that is read from the data files is converted into type-independent format and returned compressed to the calling layer. It handles locally stored data from the collection databases as well as locally mapped CSV files.

The DQL server is implemented as an IP service. The listener port number of this IP service is 3879. Thus, any node within your environment can request data from the DQL\$SRV. Up to 99 DQL\$SRV connections are allowed per node. Each DQL\$SRV process can access up to 2048 data files concurrently.

#### Cluster View Engine

The cluster view engine provides the feature of mapping performance data from different nodes for cluster-wide performance analysis. Once a cluster view is created, a virtual collection database is accessible that maps the data of the cluster view members. The advantage is that such a virtual cluster view collection database can be accessed as if it were created by the OpenVMS data collector or the SNMP extension. Thus, all methods and features to analyze single-node performance data are available for cluster views, too. Consequently, the workflow to analyze cluster view performance data does not differ from the workflow to analyze single-node performance data.

In most cases, cluster views will be created for cluster-wide performance data analysis of OpenVMS clusters. There are no restrictions, though, that state that only performance collection databases of OpenVMS cluster members can be members of a cluster view. In fact, any collection database of any node available can be added to a cluster view. The only restriction is that all collection databases of a cluster view must be created with the same sample interval.

Any data query is passed to the cluster view engine. If the data query requests cluster view data, appropriate data queries are created for all members (collection databases) of the cluster view. These queries are sent to DQL\$SRV. The data streams received from DQL\$SRV are merged and the merged data stream is returned to the calling layer. If the data query received contains no cluster view data requests the query is directly bypassed to DQL\$SRV.



### Stored Procedure Engine

The stored procedure engine enables you to define site-specific measures (statistics). User-defined statistics are calculated values that can, once defined, be accessed as if they are part of the collection databases.

Any data query is passed to the stored procedure engine. If the data query requests user-defined statistics, the data query is modified to request all base statistics necessary to calculate the user-defined statistics. The modified query is passed to the cluster view engine. Once the stored procedure engine receives data from the cluster view engine the user defined statistics are calculated according to the assigned function (procedure) and the result is returned to the caller.

### Statistics Package

Any query is passed to the statistics layer. The query is analyzed if it contains a statistics request. If this is the case, appropriate data queries are sent to the stored procedure engine. The data received from the stored procedure engine are decompressed, cached locally, processed according to the statistics request, and the final result is returned to the caller. If the query is a data query, it is sent directly to the stored procedure engine.

### PDBC\$SRV (Performance Data Connectivity Server)

The performance data connectivity server services data and statistics queries sent by the HP PERFDAT GUI. PDBC\$SRV and the DQL\$ command line utility represent the network abstraction layer of the DQL interface. Its main tasks are:

- Creating a virtual root file (memory resident) whenever a user connects to the distributed performance database using HP PERFDAT GUI. The PDBC\$SRV retains the knowledge of where the data files are located and how to access them.
- Passing the data and statistics queries to the appropriate nodes that host the data files. If the query refers to data files that are stored on different nodes, the performance data connectivity server disassembles the query, forwards appropriate queries to the nodes, consolidates the data received, and returns the result to the caller.
- The performance data connectivity server is implemented in a similar manner to the DQL\$SRV - as an IP service listening on port 5245. Up to 99 concurrent PDBC\$SRV (PC-client) connections are allowed per node.

### DQL\$ Command Line Utility

The DQL\$ command line utility, like the performance data connectivity server, is responsible for transparent access to the data files within the defined community (network abstraction). The DQL\$ utility services interactive DQL requests from the DCL command line interface. In addition the DQL\$ utility provides data content capabilities and can be used to extract trend and capacity reports from the distributed performance database manually. The DQL\$ utility is scriptable so you can automate data analysis tasks directly on the OpenVMS system.

### Performance Database File-name Cache Service

The performance database file-name cache service, DQL\_NAME, is a valid cache containing file name and particular file header information of all data files stored in the distributed performance database throughout the whole environment. It provides this file name and file header information to the components of HP PERFDAT that access performance data via the DQL interface.

The file name cache guarantees low database connectivity time when a user initially connects to the distributed performance database even though thousands of data files may be spread over all the systems of your environment.

### HP PERFDAT Statistics Package

Effectively managing system performance starts with understanding what is normal and abnormal for your environment.

Based on the historical performance data automatically maintained by HP PERFDAT, the statistics package provides various statistical methods to distinguish between normal and exceptional system behavior. These methods enable you to spot deviations quickly and easily. Deviations may indicate

problem areas or just identify opportunities for performance improvements. In addition, the statistical methods available support the efficient filtering of the statistics and parameters that characterize your system most accurately.

The statistics package is a part of the DQL interface. Thus, it is available from the GUI as well as from the command line interface (DQL\$).

The advantage of having the statistics package as a server-based implementation is that no massive data transfer between the access server and the PC-client running the GUI is necessary to receive the results. Thus, network load does not increase due to statistic queries. In addition, it is guaranteed that the runtime of a statistic query is (almost) independent of the server location (it does not really matter if the server is located locally or 100 miles away) and the bandwidth of the network.

The statistical functions implemented are:

- Min/max calculations.
- Mean value calculations.
- Standard deviation.
- Correlation.
- Integral and mean value based deviation calculation.

Elements can be ordered by any statistics of the metric. This means that the elements are displayed in ascending or descending order based on the percentage of the overall load defined by the statistics caused by each element. The time range is freely definable.

### **HP PERFDAT Online Alerting**

The online performance alerting subsystem provides real-time alerting capabilities. It supports system management to detect performance anomalies in real time. Because it does not slow down the overall system performance significantly, it is transparent to the end-user. Online performance alerting can be enabled for any active performance data collection independent of whether the data collection is performed by the OpenVMS data collector or the SNMP extension.

Once online alerting has been enabled for an active performance data collection, the alerting subsystem tracks the actual values of specific statistics collected by the OpenVMS data collector and the SNMP extension and triggers alerts if any alert condition is found to be true.

The statistics to monitor the alert conditions and the alert method are defined by alert blocks within an alert definition file. The prerequisite for enabling online alerting for an active performance data collection is that a valid alert definition file exists. An alert definition file is an easily customizable text file.

During HP PERFDAT installation, predefined alert definition files are provided. They can be used as template configuration files to create your own alert definition file or used directly to enable online alerting for appropriate performance data collections.

### **HP PERFDAT Auto-archiving Service and Housekeeping**

HP PERFDAT provides automatic data management capabilities. The HP PERFDAT archiving service carries out the archiving and housekeeping tasks reliably and unattended. All tasks performed by the service on any node within your environment are listed in order below:

- If an archive node (see HP PERFDAT environment section) is defined within your environment, all closed performance data files stored locally are moved to the archive node.
- Data collection file cleanup:
  - All data collection files stored locally with a creation date that has exceeded the *keep-time* are deleted in order to save disk space. Data collection file cleanup only affects performance data collected by the OpenVMS data collector and the SNMP extension.
  - Trend and capacity reports are not processed by the archiving service. Trend and capacity reports are kept as long as the data files are not manually deleted by system management or HP PERFDAT is uninstalled. Thus, it is guaranteed that the performance history of a system is available whenever historical performance data is required for analysis.

- If you want to prevent performance data files collected by the OpenVMS data collector or by the SNMP extension from being deleted by the archiving service you can move these files manually to the predefined directory PERFDAT\$DB\_SAVE before the *keep-time* expires. All data files stored in that directory stay accessible to the DQL interface but will not be processed by the HP PERFDAT archiving service.
- Log-file and temp file cleanup
- All software components of the HP PERFDAT environment create log-files when started. All Log-files created by HP PERFDAT components are purged with /KEEP=5. Thus, the last five versions will always be available for examination, if necessary.
- After all data management activities listed above have completed the auto-trend engine is triggered to perform automated trend and capacity reports.
- Calculating the next time to run the archiving and cleanup jobs.

The archiving process performs these tasks once a day. The user can configure the following:

- Enable/disable archive processing.
- Time of day that the archive processing starts.
- Number of days that old performance data files will be kept (*keep-time*).

### HP PERFDAT Auto-trend Engine

One of the most important tasks of performance management is trend evaluation. Trend performance data is valuable for pinpointing an unforeseen performance problem and it is a prerequisite for performance prediction while planning for the future. In order to stay ahead of the curve of how your systems will perform in the future, you have to be aware of historical performance trends.

With the HP PERFDAT automated reporting capability which is easy and flexible to configure, trend and capacity reports are created and continuously updated for any set of statistics and parameters that characterize your systems - without any necessary user action - for the lifetime of your systems.

Trend report data files created by the auto-trend engine are typically much smaller (1:100) than the performance raw-data files created by the HP PERFDAT OpenVMS data collector or the HP PERFDAT SNMP extension. This is because only a subset of performance data that most characterizes your system is extracted from the raw-data files. These trend data files are not processed by the HP PERFDAT auto-archiving service in order to guarantee the availability of the performance history for the lifetime of the OpenVMS systems. The only way to clean up trend data files is to delete them manually or to uninstall HP PERFDAT.

Four types of reports are configurable:

- Trend report.
- Capacity report.
- Day-to-day deviation report.
- Baseline deviation report

### Trend Report

A trend report compresses the selected statistics that most characterize your system. This means that the selected performance data is averaged according to the time compression. The time compression is freely definable, but has to be greater than the sample interval of the collection that created the collection database. Thus, if the time compression is set to 30 min you get 48 values per day and defined statistics in the report profile. The source data has to be collected with a sample interval smaller than 30 min.

Trend reports are helpful if the user is interested in detecting changes in system characteristics over time. If a trend report is created on a weekly basis, trend report data of week 2 and week 25 can easily be compared with the HP PERFDAT GUI. From the graphs created by the GUI you can, for example, directly identify if the level of CPU load on Monday of week 2 is still the same as on Monday of week 25, or if it has changed. You can then easily examine the way it has changed. In addition, you can directly identify if the change in the course of the workload is just limited to a specific day of the week, due to any system problem on a specific day, or if a workload change can be identified on each day of week

### Capacity Report

Capacity reports are the basis for capacity planning and forecast analysis. A capacity report contains a daily value per defined statistics. It is very easy, therefore, to identify if the workload on a system increases, decreases, or remains stable over a long period of time. From the performance point of view not all data is of the same interest. It is common to most systems that there are times it is idle and times that it is busy. For capacity planning purposes the busy times are of interest. Thus, up to 5 different time ranges can be defined for a capacity report to cover these busy periods. Only the data within these time ranges is used for calculating the average values.

### Day-to-day Deviation Report

The day to day deviation report is derived in a similar manner as the capacity report (averaging the statistics over the time period defined) but does not store the average values. It compares the actual average values to the average values for the previous day and stores the deviation of these average values (%). Such a report directly highlights on a daily basis whether or not there are significant load changes within the time periods of interest.

### Baseline Deviation Report

The baseline deviation report performs, in principle, the same calculations as the day-to-day deviation report. It does not, however, compare the actual average values to the previous day's values. Instead, it calculates and stores the deviation between the actual average values and the average values of the same day of the week from the baseline. Baseline data is a set of performance data files collected for a system covering a full week. The baseline represents a typical week where the system performance was considered "normal" based on the user's knowledge and experience. The baseline has to be defined by the system manager by moving the appropriate logical storage areas of a collection database to the predefined directory PERFDAT\$DB\_SAVE. It does not matter if the data is moved to this directory on the local node or on the archive node (see HP PERFDAT environment section). If the baseline does not cover a full week, only the days of the week are processed that are contained in the baseline. Compared to the other reports, the time period covered by a baseline deviation report file is endless. "Endless" means that the report is extended as long as the baseline data is valid. The system manager can invalidate the baseline data by simply copying a new set of data to the predefined PERFDAT\$DB\_SAVE directory and deleting the old baseline data. In this case, the next time the baseline report is triggered, the auto-trend engine detects that the baseline data has changed and a new baseline deviation report file is created.

### **PERFDAT\_MGR Management Utility**

The OpenVMS command line utility PERFDAT\_MGR is the common management interface for the HP PERFDAT components.

The main tasks of PERFDAT\_MGR are:

- Startup/shutdown of the HP PERFDAT environment.
- Control/monitor the status of HP PERFDAT OpenVMS performance data collections.
- Control/monitor the status of remote performance data collections via the HP PERFDAT SNMP extension.
- Management/control of the performance data archiving service.
- Management/maintenance of the HP PERFDAT configuration database.
- Online performance alert management.
- Management/control of the performance database file name cache service DQL\_NAME.

### **HP PERFDAT Graphical User Interface**

With the state-of-the-art HP PERFDAT Graphical User Interface (GUI) you can access performance data from anywhere on the network. Due to the analysis capabilities provided by the HP PERFDAT GUI, your IT-staff will be able to pinpoint problems and identify their causes without expert knowledge. The HP PERFDAT GUI helps you to focus on the most critical performance information, saving valuable time.

HP PERFDAT GUI supports a consistent analysis methodology for any performance data. Independent of which data and how this data was collected, the HP PERFDAT GUI simplifies the performance management process, reducing the need for training and improving the productivity of your IT-staff.

## HP PERFDAT a new performance solution for OpenVMS – Wolfgang Burger

The HP PERFDAT GUI is a Windows tool supported on Windows 2000/2003/XP. After installing the tool, the only thing you have to do before starting performance analysis work is to define an OpenVMS access server that is part of the HP PERFDAT environment (see HP PERFDAT environment section).

The HP PERFDAT GUI accesses performance data via the common DQL interface. No data file is transferred to the PC where the GUI is installed when analyzing data. Only data that is actually selected for graphing or the result of statistical queries is transferred. Since no massive data transfer occurs between the OpenVMS access server and the PC-client running the GUI, it is guaranteed that the network load does not increase significantly due to data analysis.

The main features of the HP PERFDAT GUI are:

- Easy to handle.
- Intuitive.
- Data explorer - easy data navigation (see Figure 5).
- The data explorer of the GUI provides a brief online description and the unit of each of the statistics available (see Figure 5).
- Cluster analysis capability:

As described in the previous sections, cluster views are provided by the DQL interface. Thus, all methods and features to analyze single-node performance data are available for cluster views too. Consequently, the workflow to analyze cluster view performance data does not differ from the workflow to analyze single-node performance data. Cluster views are only marked with a special icon in order to distinguish between cluster views and performance data collections of single nodes. (All the following HP PERFDAT GUI screen shots were taken during a cluster performance analysis session.)

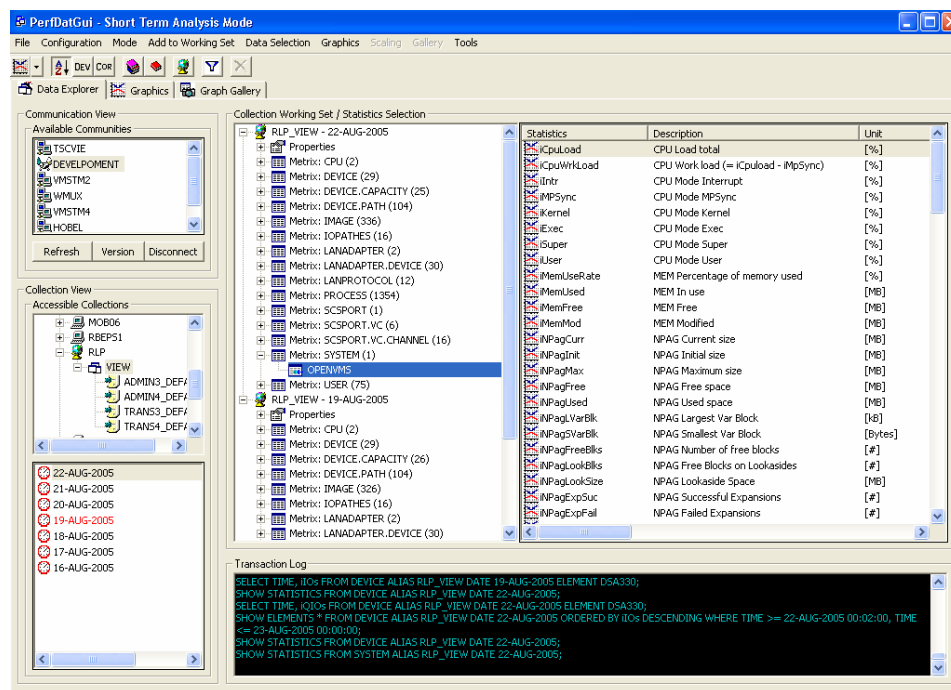

Figure 5 - HP PERFDAT GUI data explorer for easy data navigation

- State of the art graphical features like:
  - Stack/unstack functionality
  - Zoom in/out
  - Shift left/right
  - Data scanning
  - Ability to scale graph separately
  - Auto, native, and manual scaling capability
  - Data overlay capability (graphs of different time periods can be overlapped to allow visual comparison)

Figure 6 shows an example of the graphical data overlay capability of the HP PERFDAT GUI. The I/O rate caused by the RLP cluster (consisting of 4 members - see also Figure 5) on DSA303 is compared between 19-Jun-2005 and 22-Jun-2005.

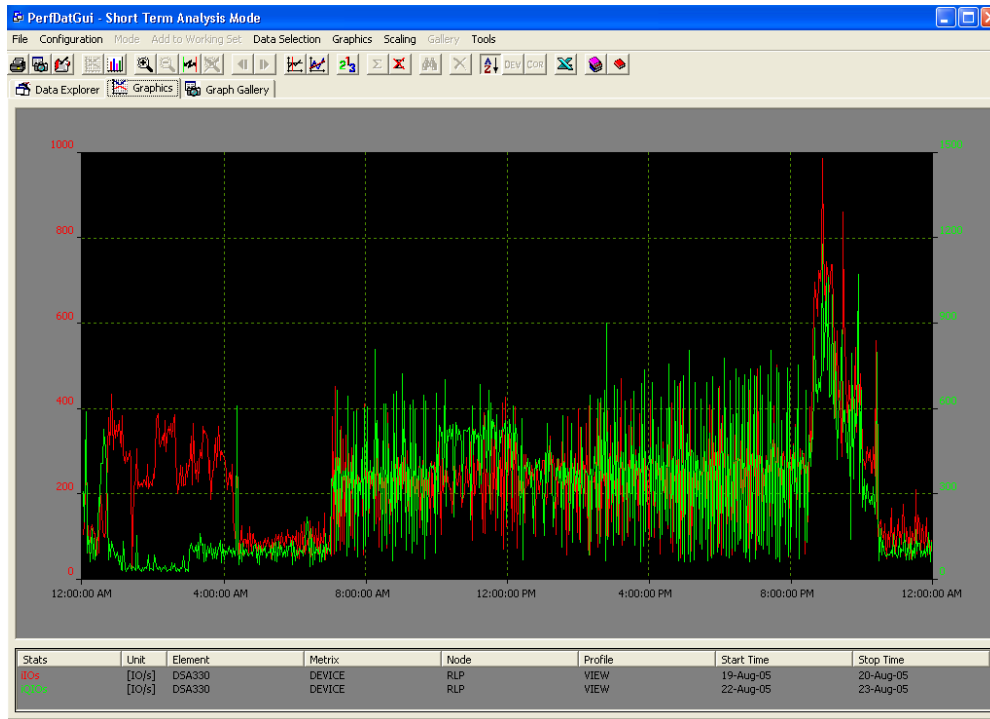

Figure 6 - Example of the data overlay capability of the HP PERFDAT GUI

- Data sorting:

The data-sorting feature can be used to sort elements of a metric by any statistics of that metric. Thus, it is very easy to identify the top resource consuming elements. For example, you can sort devices according to the I/O rate. As a result, the HP PERFDAT GUI displays the devices ordered by their I/O rate and their contribution to the overall system I/O rate in percent.

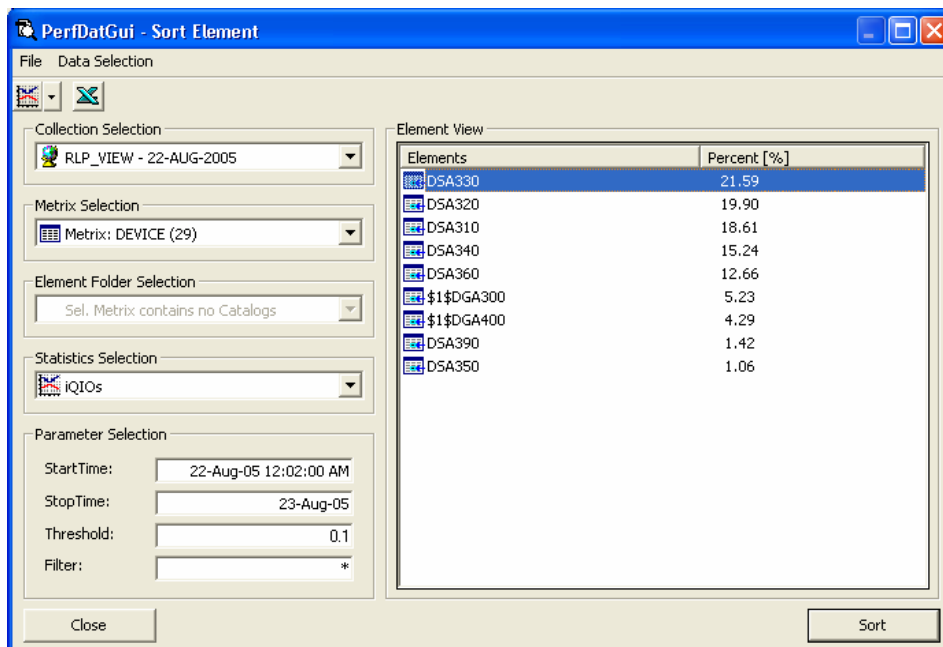
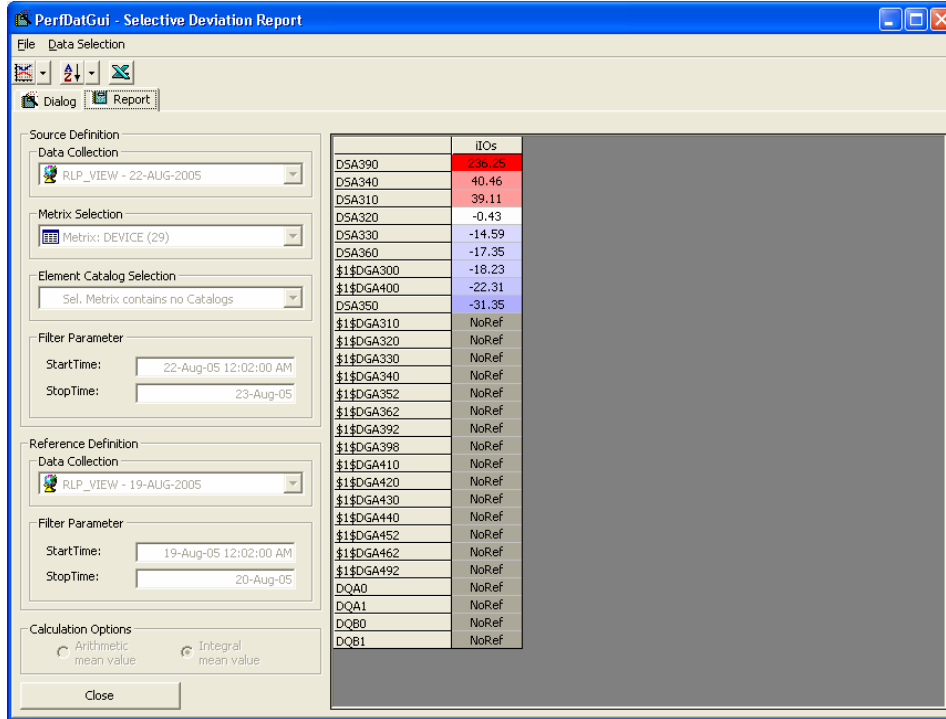

Figure 7 - Example of the data sorting capability of the HP PERFDAT GUI

- Deviation analysis capability:

The deviation analysis feature can be applied to detect any change in the workload of the system. This makes it easy to validate the workload shift due to any change (new hardware, new software releases, etc.) to your system or show how the workload evolves over time on an unchanged system.

One of the deviation analysis features is to create a deviation report that is especially valuable for “before and after” performance analysis. Figure 8 show such a deviation analysis report performed for devices. (NoRef means that no data is available for the device on the reference day, in this example 19-Jun-2005.)



**Figure 8 - Deviation report**

- Correlation analysis capability:

The data correlation feature can be used for easy dependency analysis. Correlation reports are valuable for system characterization as well as for root-cause performance analysis. Figure 9 shows an example of such a correlation report that illustrates the correlation between the direct I/O rate of all images and the I/O rate of DSA303 sorted in descending order.

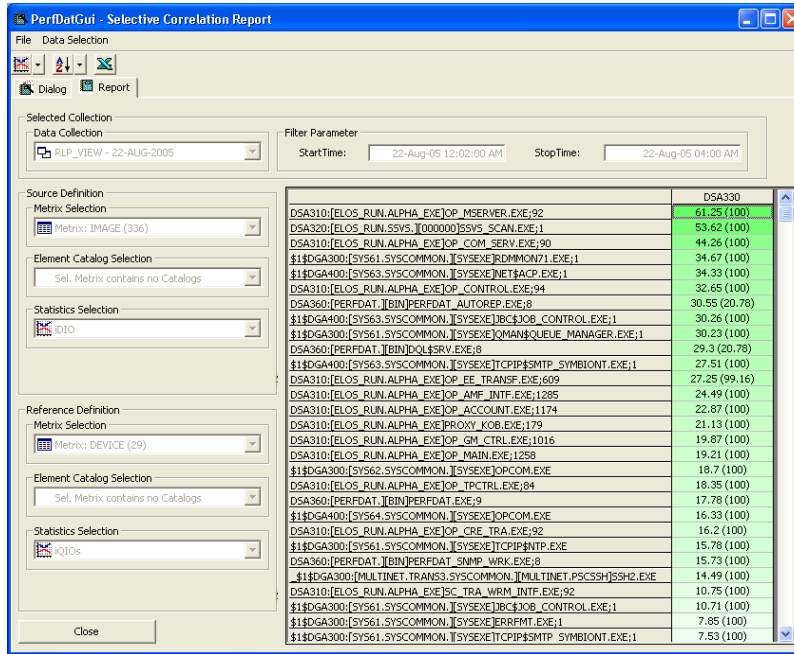

Figure 9 - Correlation report

- Predefined top statistics queries:

The graphical user interface provides a top statistics explorer (see Figure 10). The top statistics explorer sorts the elements of a metric according to a selected predefined statistics of that metric, selects the data of the 6 top resource consuming elements and displays them as a line graph automatically (see Figure 11). The statistics available in the top statistics explorer are configured in a text file for simple customization.

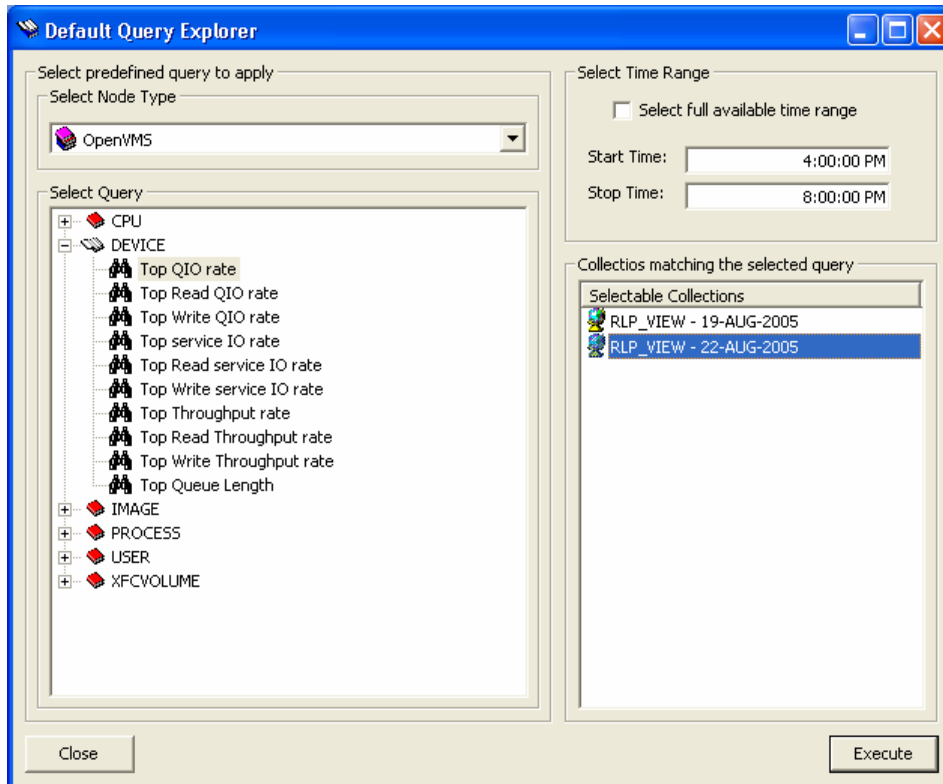

Figure 10 - HP PERFDAT GUI Top Statistics Explorer



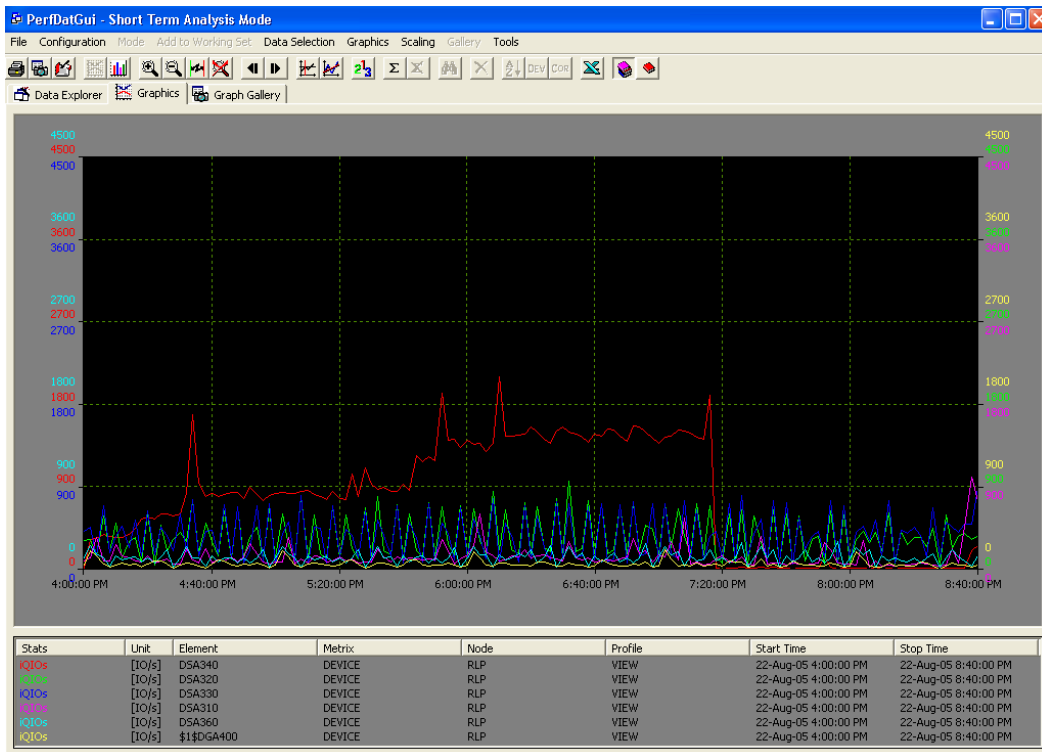

Figure 11 - HP PERFDAT GUI Top Statistics Explorer – graphics output

- Private query explorer:

You can easily define private data queries. This feature supports standard performance analysis performed on a regular basis. Once the queries for standard performance analysis have been defined, these queries can be simply applied to any other performance database that matches the criteria defined by the private queries and all the standard performance analysis is done. This saves valuable time compared to having to select all the data manually using the GUI data explorer whenever a standard analysis is performed.

- Easy to handle cluster view management and maintenance (see Figure 12).

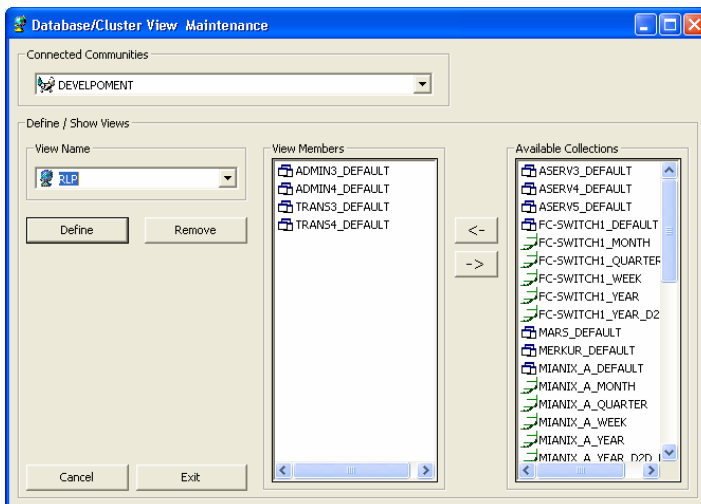
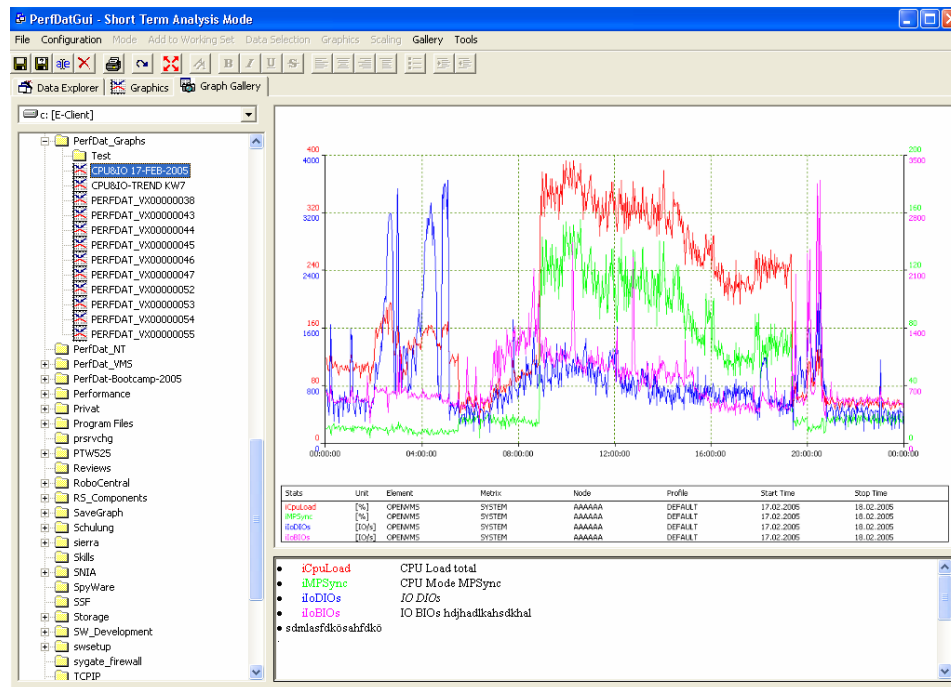

Figure 12 - Cluster view maintenance dialog window

- Multi window support for multi screen systems.
- Export capability to Excel.
- Any graphical output created can be stored locally on the PC for offline analysis / presentation (Graph Gallery - see Figure 13).



**Figure 13 - HP PERFDAT GUI Graph Gallery to view and maintain graphics stored locally on the PC**

**PERFDAT Environment**

The PERFDAT environment consists of so-called communities (see Figure 14). A community is a logical partition of the whole environment and defines the database view when accessing the data via any system within a community. All systems of particular interest can be configured within the context of a community. No rules exist that limit the configuration of such communities (such as cluster boundaries or location of the systems). The number of possible communities ranges from one to the total number of systems within the whole environment. Figure 14 shows an example of partitioning the environment into communities and the role of the systems within the communities.

The role of the systems within a community is defined by the software components running on the systems.

- OpenVMS collector system.
- SNMP agent system (collects data from SNMP server systems).
- Archive system.
- Access server.
- SNMP server system (provides performance data via SNMP).

**OpenVMS Collector System**

A system is an OpenVMS collector system if the HP PERFDAT OpenVMS data collector is running on that system.

**SNMP Agent**

A system is a SNMP agent node if the HP PERFDAT SNMP extension is running on that system and data collections are active for remote systems providing performance data via SNMP (such as Tru64 UNIX or Brocade switches).

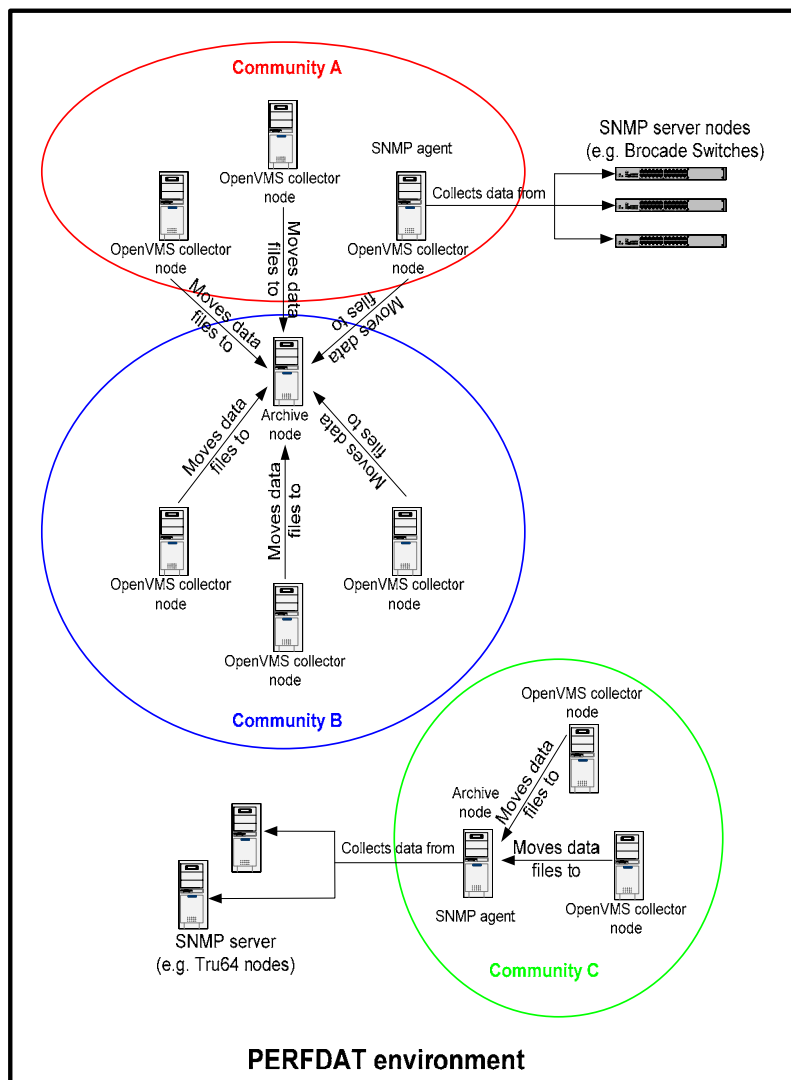

**Figure 14 - HP PERFDAT environment example.**

#### Archive System

A system is called an archive system if the HP PERFDAT Archiving service is configured on HP PERFDAT OpenVMS collector systems and/or SNMP agent to move collection data files to this system periodically.

#### Access Server

A system is called an access server, if the Data Query interface (DQL) is configured and started.

#### SNMP Server System

An SNMP server system is any non-OpenVMS system that provides performance data via SNMP and is supported by the SNMP extension.

As shown in Figure 14, an OpenVMS system configured within the PERFDAT environment can play several roles – it can be an OpenVMS collector system, a SNMP agent system, an archive system, and (not shown in Figure 14) an access server.

The main reason for defining communities is to have a selective view on the data when accessing the performance database via an access server. If you have configured your environment as shown in Figure 14, for example, and you access the performance database via any node of community C, all data collected by the community members is visible, regardless of where the data is actually stored within the community.

Accessing data via a collecting node provides a community-specific view of the distributed performance database. This behavior changes if the access server is an archive node. In this case, access is granted to all data stored locally regardless of whether the data files were created by any community member or not.

Community Example:

Looking at Figure 13, there is one node that is the archive node for community A and B, but it is a member of community B only. If you access data via that node the performance database view consists of all data of community A and all data of community B that has already been moved to the archive node. Consequently, even if the archive node is not a member of any community the user can access all data stored locally on the archive node when accessing the archive node.

If the archive node is not member of a community this does not imply that the user loses access to the data already moved to the archive node when accessing a community member. The archive node defined on the collecting node will always be queried for community data regardless of whether it is part of the community or not.

There are several reasons for defining archive nodes:

- Centralized data storage – single backup and restore location
- The statistic package provides several methods for advanced data analysis that reduce analysis time and provide the ability to identify performance bottlenecks without expert knowledge. These methods are very powerful, but running these methods may cause heavy I/O load on the system. Thus, if the data is stored on a production system, analysis runs can increase I/O load significantly and overall system performance may suffer. If data is stored on an archive node the data analysis can be done without negatively influencing the production systems.
- The auto-trend engine extracts trend and capacity reports from performance raw data. It is triggered once a day on any collecting node within your environment. Depending on the number of reports to be created automatically and their definition, the auto-trend engine may also stress the I/O subsystem. If an archive node is in use, only raw data already stored on that node will be accessed by the auto trend engine. Thus, the auto trend engine has – as long as the archive node is up and accessible – no influence on the performance of the I/O subsystem on the collecting node.

### HP PERFDAT Roadmap

New features planned for the next releases of HP PERFDAT:

- The current release of HP PERFDAT provides an easy-to-use utility to import Oracle Rdb performance data offline from binary RMU/SHOW STATISTICS files into the distributed performance database. With the next release of HP PERFDAT Oracle Rdb performance monitoring will be fully integrated into HP PERFDAT.
- The next release of HP PERFDAT will contain a performance advisory report engine. The performance advisory reporting engine will analyze performance data periodically. If a rule is fired, it will provide advisories on how to keep system performance on track.
- A future release of HP PERFDAT will contain a performance data collector for HSV storage controllers.

HP PERFDAT was developed based on OpenVMS customer requirements and in close cooperation with customers in order to exactly meet their needs. The HP PERFDAT roadmap is also triggered by HP PERFDAT customer feedback and requirements. Thus, the roadmap may change depending on HP PERFDAT customer needs.

### Summary

HP PERFDAT performance solution for OpenVMS was developed based on a customer-defined requirements list. Due to its rock-solid, layered, easily extendable software design we were able to fulfill all additional customer needs that have been brought up since its first release by adding new software layers and components within a reasonable time frame.

HP PERFDAT performance solution for OpenVMS addresses today's OpenVMS customers most urgent performance management issues by providing an unprecedented level of insight into multi-system

## HP PERFDAT a new performance solution for OpenVMS – Wolfgang Burger

performance at low cost. A complete suite of highly automated collection, filtering, charting, and trend analysis capabilities provides the customer's IT staff with accurate and complete performance information for effective performance lifecycle management.

Customers in different business areas – banks, insurance companies, semiconductor industries, healthcare, lotteries, telecom providers, and manufacturing industries – use HP PERFDAT.

For all of them, HP PERFDAT has proven the added value it provides to system and performance management. Here are just a few examples:

- A bank faced a problem when the processing time of the end-of-day jobs increased from one day to the other unexpectedly. Since they had been using HP PERFDAT continuously they had detailed performance information about the system. They used the GUI to compare performance before and after the degradation and thus they were able to identify the root cause of their problem. The write I/O response time of some (not all) production disks increased significantly. The reason was that after adding new units on their storage arrays the write-back cache performance of one of their storage arrays has degraded significantly for particular LUNs.
- A telecom provider applied a Fibre Channel patch to their systems running OpenVMS V7.3-2. After rebooting the system the overall system performance decreased significantly. After a short look at the performance data provided by HP PERFDAT and comparing the data to data collected before the patch has been applied, they found that the MPSync rate had increased dramatically. The fast-path assignments of the Fibre Channel and network devices had changed. They switched the fast-path assignments manually and the systems again performed as expected from the end-user perspective. To prove to the end users that this was the only cause of the performance loss, they ran some automated performance comparisons using the HP PERFDAT deviation analysis feature that showed that all OpenVMS subsystems performed in the same manner after manually switching the fast path assignments as they did before applying the patch.
- A lottery company upgraded to a new OpenVMS and middleware version. During the application tests, application processes sometimes crashed. These process crashes were not reproducible. Sometimes their tests succeeded and sometimes they failed. The crash and error messages provided by the middleware indicated that the crash reason was due to resource problems but there was no hint of which resources were affected. By analyzing the performance data provided by HP PERFDAT they were able to prove that the process crashes were due to misconfigured memory parameters – not OpenVMS quotas but internal middleware parameters. By adjusting these memory parameters they were able to fix this problem. In addition HP PERFDAT supported them in tuning their system. They used HP PERFDAT during all of their testing with high resolution and received a clear and complete picture of how any configuration changes of the middleware affected application and overall performance. The tuning phase led to a configuration set that provides proven optimal performance.
- A healthcare company running a huge system with more than 3000 concurrent users experienced system performance that degraded occasionally and unexpectedly during the night. By using HP PERFDAT, system managers were able to pinpoint the source of the problem. It turned out that operators – without informing system management in advance – submitted cleanup jobs that deleted up to 200.000 files at once from a directory which in turn caused the response and performance problems.
- Another bank found that the modification date of the SYSUAF files were being modified periodically although none of the system management team changed any SYSUAF records. When they first detected this security issue they used HP PERFDAT to identify the source. They started an additional data collection that monitored all I/Os from all processes to the SYSUAF files only. The next time the modification date of the SYSUAF files changed, the HP PERFDAT performance data directly showed them which process accessed the SYSUAF files and what type of access was used (Read, Write, Control I/Os).

In order to help you get the most out of HP PERFDAT within the minimum of time, the HP PERFDAT performance solution for OpenVMS is distributed as a service that includes:

- Software usage.
- Software maintenance service.

HP PERFDAT a new performance solution for OpenVMS – Wolfgang Burger

- Software upgrade service (Right to use new versions).
- Installation support and initial configuration service.

## For more information

For further information about HP PERFDAT performance solution for OpenVMS please email the author, HP PERFDAT support at or our partner, Compinia GmbH & Co KG, at PERFDAT@COMPINIA.DE.

If you want to test HP PERFDAT performance solution for OpenVMS please contact the HP PERFDAT support link at or PERFDAT@COMPINIA.DE to receive a copy of the software. When installing the OpenVMS kit for the first time, a 30-day full trial license is automatically applied. The HP PERFDAT GUI requires no separate license.